

Model 240 Electrical: Installation and Operating Instructions

ELECTRICAL

Upon receipt of your order, please review the ratings plate to verify that the model number and the electrical ratings match the product that you ordered. Electrical configuration option R & S units are CE marked in accordance with the ATEX directive. In addition the units will carry 3rd Party markings per the Division classification system. **Please read the Cautions listed on the Rating Plate as they are different for each Electrical Configuration. The markings and warnings identified on each plate are applicable only to their respective Hazardous Locations classifications. I.e; if the assembly is installed in an ATEX classified location, then the ATEX ratings plate shall govern.**

CAUTION: Do not scratch, nick, or dent mating surfaces of the gauge body and the cover during maintenance. The integrity of the flame-proof enclosure is dependent upon this metal to metal seal.



If cover bolts are lost or damaged, they **SHALL** be purchased from Mid-West Instrument for replacement. The bolts are non-standard and have been designed specifically for the referenced Hazardous Locations in this document.

Clean Metal joint area with non-abrasive cloth after any maintenance activity that requires the cover to be removed. A small amount of non-hardening grease may be applied in the joint area.

In dust environments some minor surface layering may occur. Routine cleaning shall be performed for removal of the dust layer.

FIGURE 1

FIGURE 2

WARNING: This product should be installed by personnel trained in installation of equipment in Hazardous Locations and meet the representative country's National Electrical Code.

WARNING: Electrostatic Hazard: Clean all exposed plastic surfaces with a damp cloth. Do not use solvents

WARNING: Failure to connect to the protective conductor terminal may result in a shock hazard.

WARNING: To meet Hazardous Location's Requirements, torque the cover bolts to the specified values on the Ratings plate.

WARNING: The maximum gap permitted between the body and cover is less than the maximum permitted in the standard. Therefore it is the responsibility of the user of this equipment to ensure the maximum gap between the body and the cover is not greater than 0.038mm (0.0015").

DIVISION 1 LOCATIONS:



Electrical Configurations R & S are 3rd Party Certified for Class 1, Division 1, Groups B, C & D; Class 2, Division 1, Groups E, F, & G Hazardous Locations. **All Electrical Specification Input & Output Combinations are approved for this classification.**

This configuration has T6 Temperature classification for all input and output combinations except for the H input option which has a T4A Temperature classification.

For Electrical Specification Input Option A in combination with Output Options A through H, a seal is not required. This configuration can also be classified as a "Simple Apparatus" for use in an Intrinsically Safe System.

For Electrical Specification Input options B through H in combination with Output option R, a seal is required within 18" of the enclosure. Please refer to National Electrical Code requirements.

ATEX / IECEx CERTIFIED (Group II Category 2 Gas & Dust Atmospheres):



Electrical Configurations R & S are ATEX and IECEx Certified for Gas & Dust Atmospheres as:

Ex d IIB + H ₂	T 6 (-40°C ≤ Ta ≤ 70°C)Gb
	T 5(-40°C < Ta < 85°C)Gb
Ex tb IIIC IP65	T85°C (-40°C ≤ Ta ≤ 70°C)Db
	T100°C (-40°C < Ta < 85°C)Gb

Ex II 2GD IP65

for Electrical input options A in combination with Electrical Output options A, E, & H

Ex d IIB + H₂ T 6 (-40°C ≤ Ta ≤ 70°C)Gb
Ex tb IIIC IP65 T85°C (-40°C ≤ Ta ≤ 70°C)Db

 II 2GD IP65

for Electrical input options A in combination with Electrical Output options A, E, & H and input options B thru G in combination with Output Option R

Ex d IIB + H₂ T 4 (-40°C ≤ Ta ≤ 70°C)Gb
Ex tb IIIC IP65 T135°C (-40°C ≤ Ta ≤ 70°C)Db

 II 2GD IP65

for Electrical input option H in combination with Electrical Output option R

Installation



Tools Required: 8mm deep metric socket.

Torque wrench
Adjustable or 1.125" wrench (process connections)
Switch Adjust (2 switch units only)

CAUTION: DO NOT EXCEED THE MAXIMUM RATED WORKING PRESSURE STATED ON THE RATINGS PLATE.

CAUTION: ALWAYS USE A WRENCH (1.125") ON THE SWITCH'S PROCESS CONNECTIONS TO KEEP THEM IN PLACE WHILE TIGHTENING AND LOOSENING CUSTOMER SUPPLIED PROCESS FITTINGS.

CAUTION: USE CABLE SUITABLE FOR SPECIFIED TEMPERATURE CLASS. MAXIMUM INTERNAL CABLE ENTRY TEMPERATURE RISE 15°C – CABLING TO BE SUITABLE

WARNING: VERIFY MEDIA COMPATIBILITY WITH ALL WETTED PARTS. RANGE SPRING IS MANUFACTURED FROM 316SS. MEDIA INCOMPATIBILITY WITH THE SPRING OR THE BODY OF THE GAUGE CAN RESULT IN AN IGNITION HAZARD DUE TO CORROSION.

WARNING: USE PRESSURE LIMITING DEVICES TO LIMIT PRESSURE SPIKES BELOW THE PROOF PRESSURE OF THE GAUGE.

Locate unit where temperatures will be within the limits of the device hazardous locations ratings.

On liquid service the instrument should be mounted **below** the process connections to facilitate self bleeding. On gas service it should be located **above** the process connections to promote self-draining. If the process contains particulates, a "pigtail" loop or drop leg (manometer "U-tube" configuration) in the tubing will minimize the possibility of it migrating into the instrument. An optional pipe mounting kit is available for mounting the gauge to a 2" vertical or horizontal pipe (Fig. 6).

Connect process piping or tubing to the pressure ports stamped High and Low on the gauge body. Connections are either 1/4" FNPT or 1/2" FNPT dependent upon the option selected when the order was placed.

Reverse pressure will not damage the instrument, however the switch and indicator (if supplied) will not function properly.

WARNING: ELECTRICAL CONNECTION SHALL BE MADE WITH A CABLE ENTRY OR STOPPING BOX CERTIFIED FOR USE FOR THE DESIRED HAZARDOUS LOCATION CERTIFIED FOR CONDITION OF USE, AND CORRECTLY INSTALLED. THE CABLE ENTRY DEVICE AND ANY THREAD ADAPTOR SHALL BE SUITABLE FOR THE EQUIPMENT, THE CABLE AND THE CONDITIONS OF USE AND SHALL BE CERTIFIED AS EQUIPMENT (NOT A COMPONENT) UNDER THE EC TYPE EXAMINATION CERTIFICATE TO DIRECTIVE 94/9/EC

WARNING: WHEN USED IN AN EXPLOSIVE DUST ATMOSPHERE, THE CABLE ENTRY DEVICE AND THREAD ADAPTOR SHALL MAINTAIN THE INGRESS PROTECTION OF THE ENCLOSURE.

WARNING: IN HAZARDOUS LOCATIONS REMOVE POWER FROM THE UNIT BEFORE REMOVING THE COVER.

WARNING: DURING MAINTENANCE DO NOT DISCONNECT FROM EXTERNAL EARTH CONDUCTOR UNTIL ALL POWER GENERATION SYSTEMS HAVE BEEN TURNED OFF.

WARNING: USE PRESSURE LIMITING DEVICES TO LIMIT PRESSURE SPIKES BELOW THE PROOF PRESSURE OF THE GAUGE.

WARNING: DO NOT TOUCH SURFACE OF THE PRINTED CIRCUIT BOARD IF THE UNIT IS POWERED. HIGH VOLTAGE MAY BE PRESENT.



Remove the cover by using an 8mm hex driver to loosen the bolts from the underside of the gauge body. (see previous cautions and warnings). The bolts are captive in the body of the gauge. A deep metric socket is recommended in order to clear an interference near the bezel of the gauge. (0.48 diameter min 1" long).

Connections to the terminal strip are identified in the following sections. The terminal strip is compatible for wire ranges from 12-22 AWG (3.3 - .32 mm²). Optionally, each connection can be field wired with multiple wires connected to one contact. You may connect two (2) 22 – 16 AWG (0.33 -1.3 mm²) wires into one connection. Recommended screw torque is 6 in. lbs. (0.113 newton-meter) to tighten the terminal strip screw.

Each Assembly is provided with strain relief clamps. Use these clamps to provide strain relief when field wiring the instrument.

For the non-gasketed assembly, clean both mating metal surfaces prior to re-assembly (see previous cautions and warnings). A small amount of a suitable non-hardening grease may be applied to the mating metal surfaces.

Replace cover making sure there are no wires pinched between the cover and the gauge body. Re-tighten the screws within the range of 60 to 75 in-lbs.

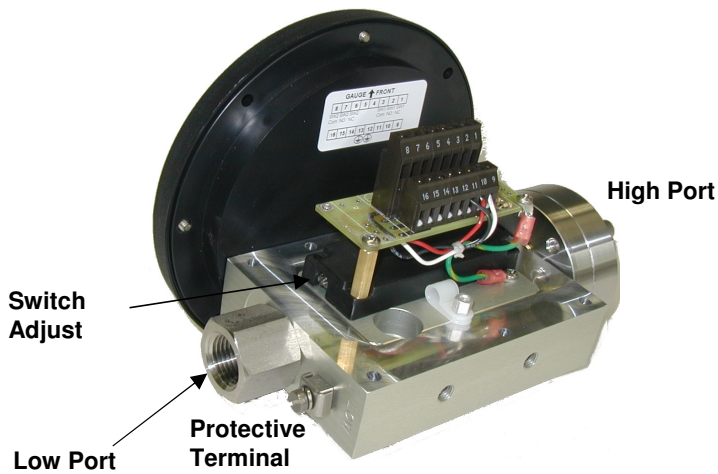

FIGURE 3

Switch Configurations:

The Model 240 indicating / non-indicating differential pressure switch is configured with one of the outputs identified in the table below.

OUTPUT RATINGS (Resistive Load)

Type	SPST	SPDT	SPDT	DPDT Relay
ELEC Spec.	A	A	A	B,C,D,E,F,G,H
Output Option Code	E	H	A	R
*Power	60 W	60 W	3W	N/A
Max. Current	3 Amps	1.0 Amps	0.25 Amps	10 Amps
Max. Volts VAC/ VDC	240	240	125	277 / 30
Setting** (F.S.)	15% to 100%	25% to 100%	15% to 100%	15% to 100%
Hysteresis (Max/Nom)	20% / 9% Full Scale(F.S.)	25% / 18% Full Scale(F.S.)	15% / 6% Full Scale(F.S.)	20% / 10% Full Scale(F.S.)
Repeatability	1% F.S.	1% F.S.	1% F.S.	1% F.S.

Table I

* Product of the switching voltage and current shall not exceed the power rating of the device.

** For ranges ≥ 60 PSID, minimum adjustability = 25%.

Hermetically Sealed Switch Outputs:

Electrical Specification Input Option “A” identifies that your unit does not need input power to operate the switch output and that your unit is equipped with Hermetically Sealed Reed switches. The “A” option matched with Output Options A, E, & H identifies the output capability of your unit. Depending on the electrical configuration specified on the order (A, B, R, or S), your unit will be equipped with 1 or 2 independently adjustable reed switches.

Interface to the 16 position terminal strip shown in Figure 4 is defined in Table II.

Electrical Options	Qty Sw.	Function	Terminal Connections & Switch Screw Adjust Location	
			Low Port Screw Adjust	Hi Port Screw Adjust
RAA, RAH	1	SPDT	1(COM), 2(NO), 3 (NC)	No Connection
SAA, SAH	2	SPDT	1(COM), 2(NO) 3 (NC)	8(COM), 7(NO) 6 (NC)
RAE	1	SPST NO	1,2	No Connection
SAE	2	SPST NO	1, 2	8, 7

Table II

Chassis connection is to position 12 or 13.

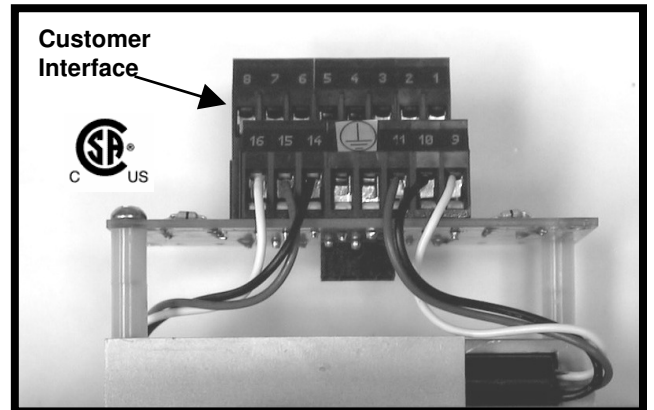

Figure 4: Reed Switch Terminal Strip Output Interface

Customer Interface for the Reed Switch Output Option will be via connections 1 through 8 and connections 12 or 13. Do not loosen the connections at positions 9, 10, 11, 14, 15 , or 16.

All switch types are field adjustable. The defined range of the adjustment is specified in Table I above. All switches come with a decal to identify adjustment direction to increase the set point. **Do not use excessive force when rotating the adjustment screw as the adjustment mechanism may be damaged (See Figure 3).** A 3/32 hex tool is required to adjust the switch(es). For 2 switch units, a small hex tool is supplied to adjust the switch on the High Port side.

Note: Switches can be set below the defined minimum set point however, the switch may not remain activated at maximum PSID. If the unit is set below the defined minimum set point, the customer should verify that the switch remains activated from the set point to full over range of the gauge.

Provide standard protection techniques for the switch contacts for capacitive and inductive loads. Use current limiting techniques near the switch to protect the contacts due to high inrush (i.e.; in line resistor or inductor) for long cable interfaces. Provide clamping devices at or near inductive loads (i.e.; relay). **Maximum wire length between the 3W switch and its load, should not exceed 70 – 100 Feet. for 120 VAC applications.** Contact the factory for assistance regarding this condition.

Simple Apparatus:

Electrical configurations R & S in combination with Input option A, in combination with output options A, E, or H are classified as “Simple Apparatus” when used in Intrinsically Safe circuits. These configurations comply with EN50020:2002 clause 5.4. In addition, per the agreement of CENELEC sub-committee SC31-3, simple apparatus do not fulfill the definition in Article 1 of Directive 94/9/EC and therefore fall outside the scope of the Directive. Also, they do not require a declaration of conformity or CE mark related to this directive.

If the product is used as “Simple Apparatus within a Hazardous atmosphere please note the following items:

- 1) The switch shall be installed by personnel trained in the installation of equipment in Hazardous Locations.
- 2) The configurations classified as intrinsically safe have no source of internal heating. For temperature classification, take into account the temperature of the process and the maximum temperature specified in this document.
- 3) It is the responsibility of the user to identify that the installed device is identified as a “Simple Apparatus” device. For the identified configurations it is possible that for an intrinsic safe system that the switch could be installed in a location outside of the Hazardous Locations marking identified on the ratings plates(s)

Relay Output Interface

Electrical Specification Input Option “B” through “H” identifies that your unit will need input power to operate the relay output (output option R). Depending on the electrical configuration specified on the order (R or S) your unit will be equipped with 1 DPDT output or 2 independently adjustable SPDT Relay outputs. Table I identifies the load ratings and the adjustability range of the output.

Interface to the 16 position terminal strip shown in Figure 5 is defined in Table III.

The relay outputs are uncommitted and may be connected to any load provided the load is within the output ratings of the relay. The terminal strip is compatible with 22 – 12 Awg. wire.

Deviations from the above configurations may exist. Therefore check the description block of your order to verify your configuration.

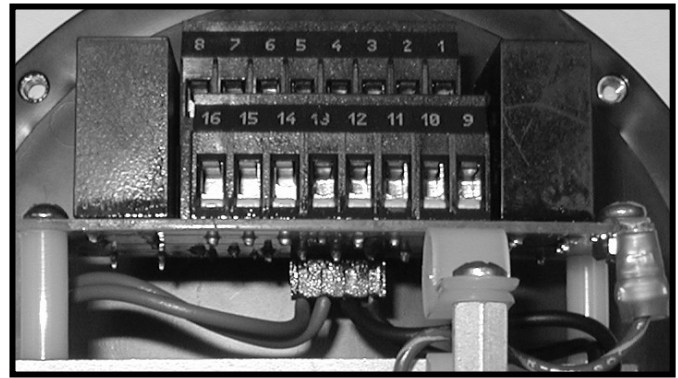

FIGURE 5

Electrical Options	Qty Sw.	Func.	Terminal Connections					
			Switch Adjust Lo Port			Switch Adjust Hi Port		
			Com	NO	NC	Com	NO	NC
R*R,	1	DPDT	1 9	2 10	3 11	X	X	X
S*R,	2	SPDT	1	2	3	8	7	6

TABLE III

* = Input Power Options B, C, D, E, F, G, & H

Input Power = Position 4 + for DC; Hot for AC
Position 5 Rtn. for DC, Neutral for AC

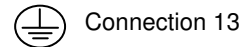

See Decal on Inside Cover for additional connection information.

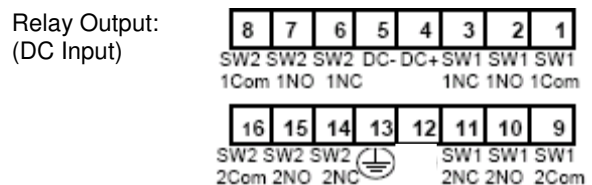
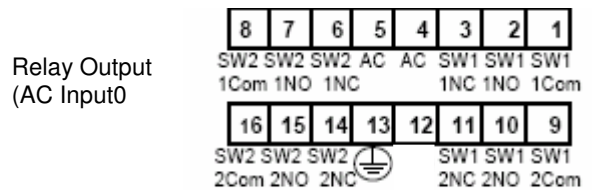
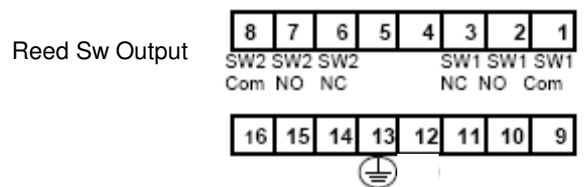

TROUBLE SHOOTING

1. Gauge does not indicate differential.

- A. Check for proper hook up, high to "hi" and low to "lo".
- B. Make certain block valves are open and, if using a 3-valve manifold, that the equalizer (balance) valve is closed.
- C. If A & B check out correctly, loosen or disconnect the high pressure line to determine if there is pressure to the instrument.
- D. If there is pressure to the instrument, check to determine that there is differential across the unit being monitored. If so, contact the factory for assistance and/or an "RGA" (return goods authorization) number to return the instrument for repair or replacement.

2. Switch doesn't function

- A. Make sure you have supplied power (proper voltage) to the unit if you ordered the power relay unit. The reed switch output units do not require power.
- B. Check that you are wiring to the correct Interface terminals.
- C. Check the reed switch interfaces to the terminal board for loose connections. For the power relay the reed switch(es) connect to the terminal strip on the underside of the PCB. For the reed switch outputs the reed switch(es) connect to positions on the bottom row of the terminal strip on the top of the PCB (see Figure 4).
- D. Make sure that the switch load does not exceed the specified wattage rating of the switch. (steady-state and transient). For this condition you must contact the factory

3. Gauge accuracy and set point problems:

- A. Verify gauge is not in an electromagnetic / magnetic environment. i.e.; close proximity to high current power lines.
- B. All others, contact the factory for assistance

FIGURE 6

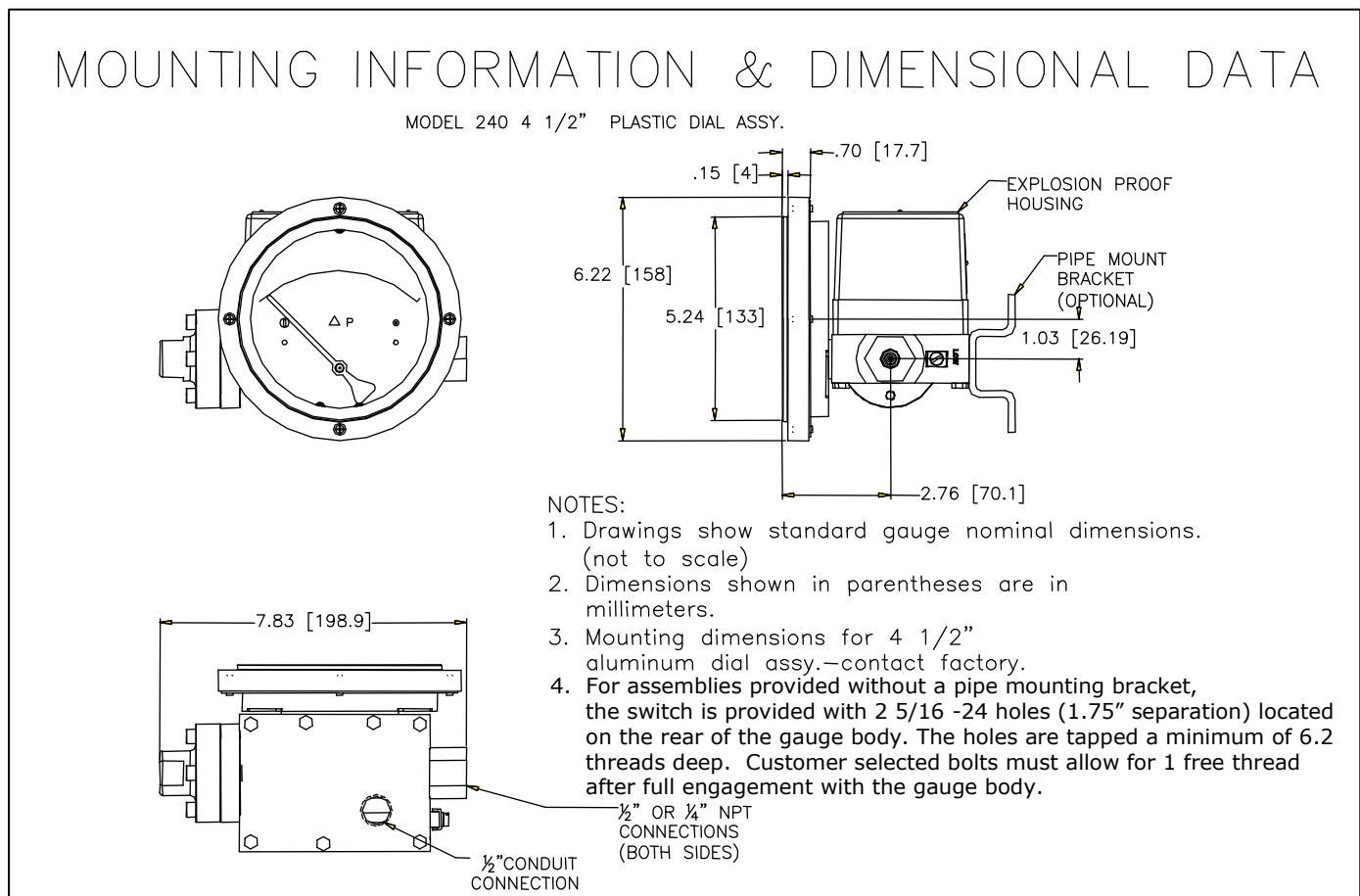

STANDARD MODEL SPECIFICATIONS

240-AC-02-0(RAA), 1500 P.S.I.G. Working pressure, aluminum wetted pressure containing assembly, 1/4" FNPT end connections, stainless steel/ceramic magnet internals, Buna-N seals, 4 1/2" round dial, engineering plastic gauge case with shatter resistant acrylic lens. One 3W, 125 VAC/VDC SPDT reed switch with terminal strip, aluminum explosion proof switch enclosure with 1/2" FNPT electrical access. **ATEX / IECEx Certified**,

240-SC-02-0(RAA), 1500 P.S.I.G. Working pressure, 316 S.S. wetted pressure containing body assembly, 1/4" FNPT end connections, stainless steel/ceramic magnet internals, Buna-N seals, 4 1/2" round dial, engineering plastic gauge case with shatter resistant acrylic lens. One 3W, 125 VAC/VDC SPDT reed switch with terminal strip, aluminum explosion proof switch enclosure with 1/2" FNPT electrical access. **ATEX / IECEx Certified**

PART NUMBERING SYSTEM

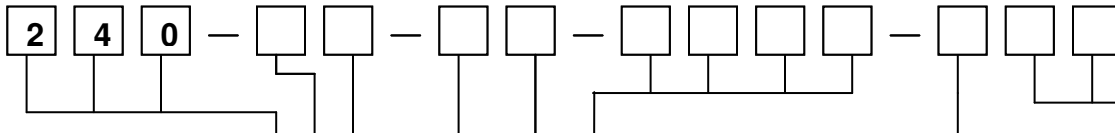

1. BASIC MODEL NUMBER

2. MATERIAL

- A. Aluminum Body, Aluminum Bore , S.S. Piston
- S. Aluminum Body, 316 S.S. Bore, S.S. Piston
- Z. Special ¹⁰

3. DIAL SIZE (Engineering Plastic Housing Unless Stated Otherwise)

- C. 4-1/2" Round Dial Uni-Directional Dial
- F. 4-1/2" Round Aluminum Dial Housing
- T. Differential Pressure Switch Only (Without Indication)
- Z. Special (Uncoded Options) ¹⁰

4. SEALS

- 0. Buna N (Standard)
- 1. *Viton®
- 5. Ethylene Propylene
- 9. Special (Uncoded Options) ¹⁰

5. CONNECTIONS

- 2. 1/4" FNPT End Connections (Standard)
- 7. 1/2" FNPT End Connected
- 9. Special (Uncoded Options) ¹⁰

6. OPTIONS (Up to four options)

- 0. None
- F. Pipe Mounting Kit (Carbon Steel)
- G. Pipe Mounting Kit (Stainless Steel)
- M. Maximum Indicator Follower Pointer ¹⁰
- Q. CRN (Canadian Registration Number)
- S. Shatterproof lens (4 1/2 Metal Front Only)
- T. Oxygen Cleaning
- U. S.S. Tag with S.S. Wire
- V. S.S. Tag with S.S. Screw
- Z. Special (Uncoded Options) ¹⁰

NOTE: Not all options available in combination with Other options.

* Viton® is a Registered Trademark of DuPont Dow Elastomers

7. ELECTRICAL CONFIGURATIONS (Select One)
(For DP ranges greater than or equal to 60 PSID the Switch adjustability is from 25% - 100% of the Full Scale Range for all switch options) (T6 Temperature Class unless specified otherwise)

- A. One Control Switch in NEMA4X Enclosure ^{1, 6, 8}
- B. Two (2) Control Switches in NEMA4X Enclosure ^{1, 6, 7, 8}
- J. One (1) Control Switch in NEMA7 (Exp. Proof Encl.) ²
- K. Two (2) Control Switches in NEMA7 (Exp. Proof Encl.) ^{2, 7}
- R. One (1) Control Switch in Ex d encl. (CE Marked) ^{2, 9}
- S. Two (2) Control Switches in Ex d encl. (CE Marked) ^{2, 7, 9}
- Z. Special ¹⁰

8. ELECTRICAL SPECIFICATIONS (Select 1 Input and 1 Output)

INPUT OPTIONS:

- A. No Input Power (For Reed Outputs A, E, F, G, H)
- B. 5/6 VDC
- C. 12 VDC
- D. 24 VDC
- E. 48 VDC
- F. 24 VAC
- G. 120 VAC
- H. 240 VAC

R RELAY
OUTPUT OPTION

For H Option (T4(ATEX) T4A (North Amer.) Temperature Class)

9. OUTPUT OPTIONS: (Resistive Load) ³

- A. S.P.D.T., Reed, 3 W, 0.25 Amp, 125 VAC/VDC ⁴
- E. S.P.S.T., Reed, 60 W, 3 Amp, 240 VAC/VDC (N.O.) ⁴
- H. S.P.D.T., Reed, 60 W, 1 Amp, 240 VAC / VDC ⁵
- R. D.P.D.T. Relay, 10 A, @ 30 VDC, 120 / 240 VAC ^{4, 8}
- Z. Special (Contact Factory) ¹⁰

- (1) Complete Assembly 3rd Party Certified, Rated Class I, Div II, Groups A,B,C, & D; Class II Division II, Groups F & G. (R Output option excluded)
- (2) Complete Assembly 3rd Party Certified, Rated Class I, Div I, Groups B,C, & D; Class II Division I, Groups E, F, & G.
- (3) For output options A through H, the product of the switching voltage and current shall not exceed the power rating.
- (4) Switch adjustable range 15 –100 % of the gauge full scale range.
- (5) Switch adjustable range 25 – 100 % of the gauge full scale range.
- (6) Enclosure Type 4/4X
- (7) For Electrical configurations B, K, & S SPDT relay output only.
- (8) Electrical configuration A & B in combination with Output Option R is not rated for hazardous locations.
- (9) ATEX / IECEx RATED; CE MARKED Ex d IIB + H₂ , Ex tb IIIC II 2GD IP65 (Temp classifications vary dependent on Electrical Input and Output options. See IM 240_atex for more detail),
- (10) Not available with Electrical Configurations R & S.

PROOF PRESSURE: 6,000

WORKING PRESSURE: 1500 PSI

TEMPERATURE LIMITS:

- 40°C < Ta < 70°C for output option R (Relay Output).
- 40°C < Ta < 85°C for Electrical Input Options A in combination with Electrical Output options A, E, & H.

- These limits are based on the entire instrument being saturated to these temperatures. System (process) temperatures may exceed these limitations with proper installation. Contact our customer service representative for details.

STANDARDS: The Model 240 Series differential pressure gauges either conform to and/or are designed to the requirements of the following standards:

ASME B1.20.1	NEMA Std. No. 250
ASME B40.1	SAE J514
CSA-C22.2 No. 14, 25, and 30	EN60079-0, EN60079-1 and EN13463-1
UL Std. No. 50, 508, 698, and 1203	EN60079-31, EN13463-1

Pressure Equipment Directive:

The products manufactured by Mid-West Instrument have very small internal volumes. The small internal volumes result in Mid-West Instrument products falling below category I for non-hazardous gases, hazardous liquids, and non-hazardous liquids. They also fall below category I for hazardous gases at or below pressures of 200 bar. Per article 3, paragraph 3 these products shall not bear the CE marking and shall be designed and manufactured with "sound engineering practice". Our sound engineering practice is supported by our quality system in accordance with CSA B51-03 Annex F third party certified by QMI.

Applications for hazardous gases at pressures above 200 bar will require evaluation to the Pressure Equipment Directive which may be performed in the future.

Warning: The suitability of the application and installation of this differential pressure switch is the responsibility of the end user. The applicable certifications, listings apply to the differential pressure switch only.

**Mid-West[®]
Instrument**

6500 Dobry Dr. Sterling Heights, MI 48314
(586)254-6500 FAX (586)254-6509
E-Mail: sales@midwestinstrument.com
Web Page: www.midwestinstrument.com